

Vehicle transporter

Operating instructions

Part 2 - FTK



MACHT'S MÖGLICH

en



Name and address of manufacturer:

Humbaur GmbH
Mercedesring 1
86368 Gersthofen
Germany

Tel. +49 821 24929-0
Fax +49 821 249-100

info@humbaur.com
www.humbaur.com

Name and address of dealer:

Name: _____

Address: _____

Telephone: _____



Please enter the name of your dealer.

Notes on use/Target group



PART 2 - "FTK" Original Operating Instruction Manual (for vehicle transporters)

This "FTK" operating instruction manual (Part 2) is intended for you as the user of a ready-to-use trailer. It provides detailed steps on how to handle the FTK trailer. It contains all of the relevant details on safe operation, care/cleaning, maintenance/servicing, troubleshooting, and decommissioning/disposing of the trailer. This specific operating instruction manual (Part 2) is on the enclosed CD. You can also download it from **www.humbaur.com/download: Operating Instruction Manual**.

PART 1 - "Trailers up to 3.5 to - General Points"

For all other general information on trailers up to 3.5 to, see the operating instruction manual "Trailers up to 3.5 to (General Points - Part 1)".

- PART 1 and PART 2 together form the complete documentation for your trailer which you as the user should have at your disposal.



Read this operating instruction manual carefully and completely before using your trailer for the first time and observe all of the instructions, safety information, and warnings. Comply with the steps for handling the trailer.

- Non-observance of any of the documentation can cause injuries to you and to other persons or can cause material damage.
- Non-observance may invalidate your guarantee entitlement.
- Keep this operating instruction manual carefully for the entire service life of your trailer.
- It forms part of the product and also serves as a CHECK LIST for regular inspections of your trailer.
- We advise you to keep the operating instruction manual in the car and to keep it at hand in case you need to consult it.
- It should be passed on to the new user/owner if you rent out or sell your trailer.





In addition, as a road user, you are obliged to observe all national regulations for driving a vehicle and trailer and to comply with your obligations as the owner of a commercial vehicle.

- This includes regularly carrying out maintenance and care tasks and periodically subjecting your trailer to an overall technical inspection.
- You must make sure that you are aware of any special stipulations which are specific to your country.

Table of Contents

Notes on use/Target group	2
1 Identification	4
1.1 Declaration of Conformity	4
2 Product Description	5
3 Intended Use	8
4 Foreseeable Misuse	8
5 General Safety Instructions	8
6 Loading and Unloading	8
6.1 Load distribution	8
6.2 Securing a load	9
6.3 Lowering the load platform	9
6.4 Positioning the drive-up ramps	10
6.5 Loading the Trailer	11
6.6 Securing the drive-up ramps	12
6.7 Unloading the trailer	13
7 Driving	14
8 Parking	14
9 Cleaning/Maintenance/Serviceing	14
9.1 Care/Cleaning	14
9.2 Maintenance/Serviceing	15
10 Troubleshooting	17
11 Decommissioning / Disposing of the Trailer	18
11.1 Decommissioning the Trailer	18
11.2 Disposal	18

1 Identification

- ▶  Put a cross next to the type of trailer you have acquired.
- ▶  Please read the general operating instruction manual
"Trailers up to 3.5 to - General Points (Part 1)".

Product name: FTK (vehicle transporter)

4000 Series: _____

Single-axle

4100
Type 1 FTK 133520

4101
Type 1 FTK 153520

Tandem

4105
Type 1 FTK 204020

4107
Type 1 FTK 274020

1.1 Declaration of Conformity



Humbaur GmbH hereby confirms that they comply with all relevant EU directives for the registration and safe use of FTK trailers.

You can request a detailed EU declaration of conformity from us separately.

2 Product Description

The FTK is a sturdy and low-maintenance car transporter, without hydraulics.

The load platform tilts automatically after releasing the eccentric clamping devices - using integrated dampers.

After a vehicle is loaded via aluminium drive-up ramps, the load platform automatically lifts back to the starting position - by shifting the weight back to the front.

The bolted chassis makes it possible to replace individual parts in the event of damage.

The galvanised load platform and chassis guarantee a long service life for the trailer.

The drive-up ramps can easily be manually adjusted to the track width of the vehicle to be loaded.

The load is secured using commercially available car lashing straps and the holes integrated in the load platform.

The single axle and tandem variants of the FTK permit a wide range of applications for payloads of 860 kg - 2,070 kg.

As an option, the FTK can be fitted with the following accessories: Hydraulic cylinders for tilting the load platform, spare wheel with retainer cage, shock absorbers (for 100 km/h), plug-mounting rope winch, wheel stop.

The following illustrations show the special features and spare parts for the FTK trailers.



FTK - Single axle, tilted

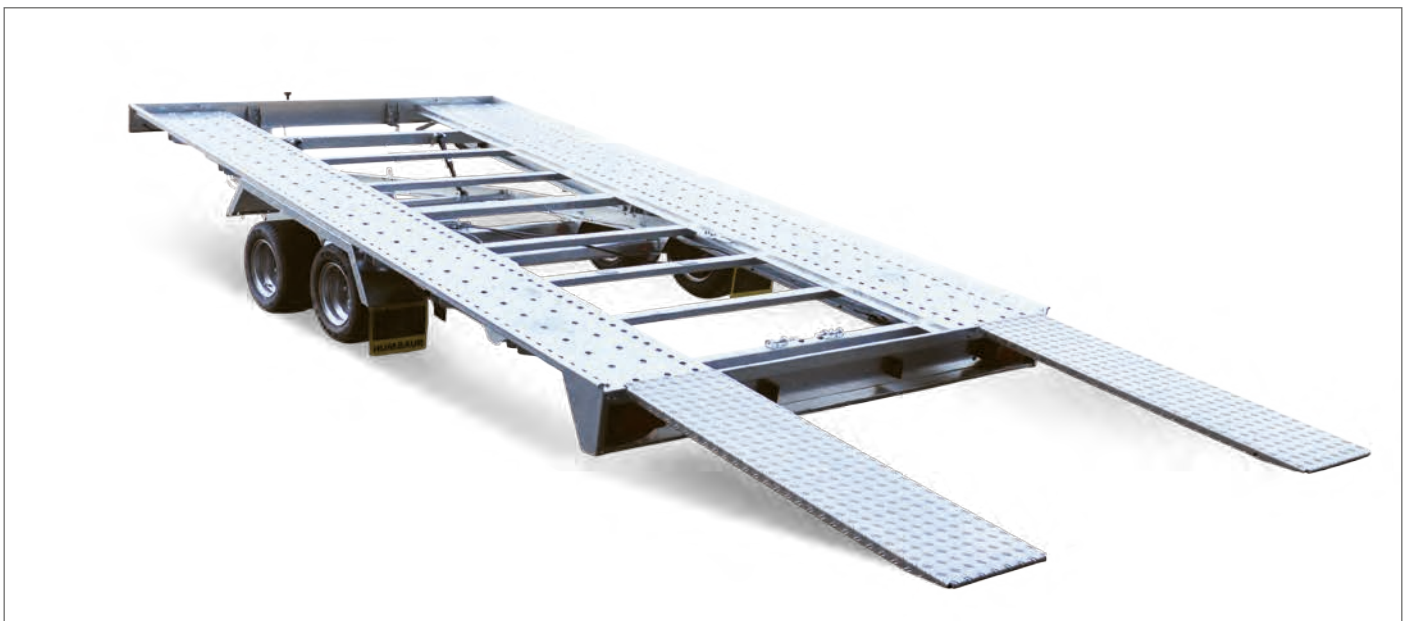

FTK - Tandem, tilted



FTK - Single axle, lateral

1. Ball head coupling with breakaway cable
2. Electric plug
3. Handbrake lever
4. Drawbar support
5. Jockey wheel
6. V-shaped drawbar frame
7. Eccentric clamping device
8. Light (front)
9. Wheels/tyres/axle
10. Spray flap
11. Wheel chock
12. Lighting (rear)
13. Underride guard
14. Number plate light
15. Drive up ramp lock
16. Drive up ramp
17. Loading platform
18. Damper

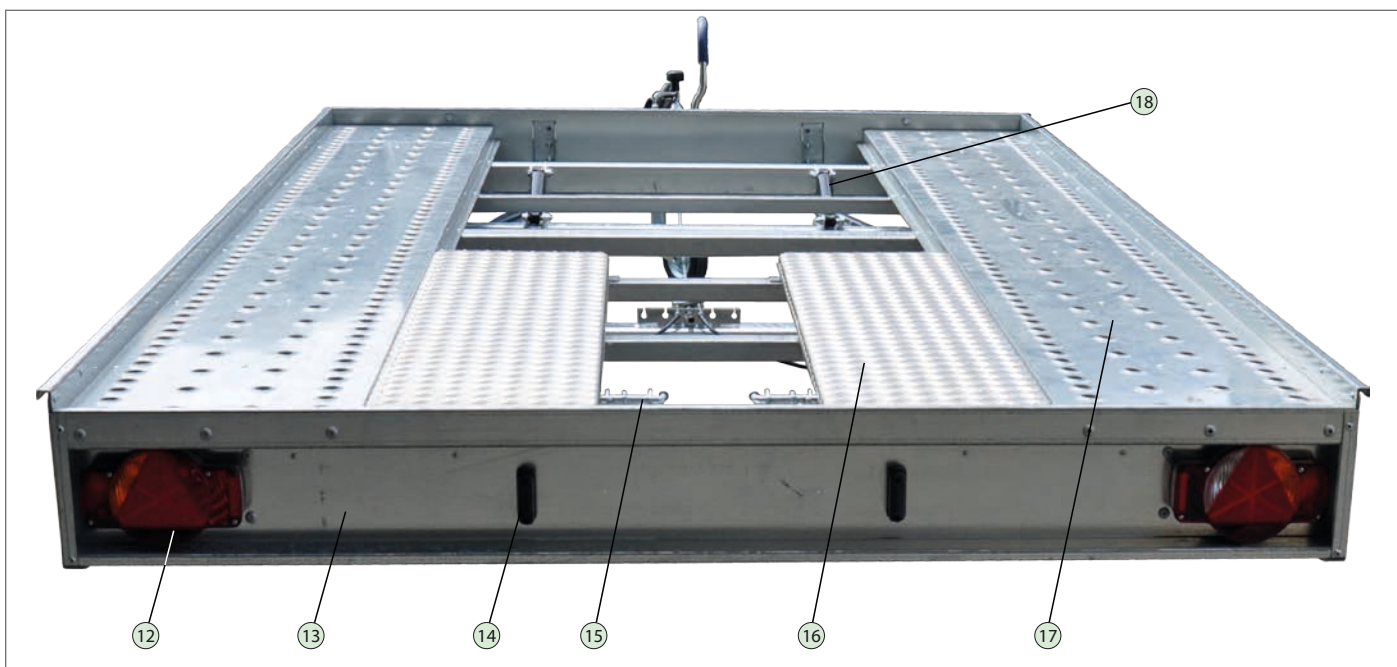

FTK - Single axle / Tandem from the rear

Accessories

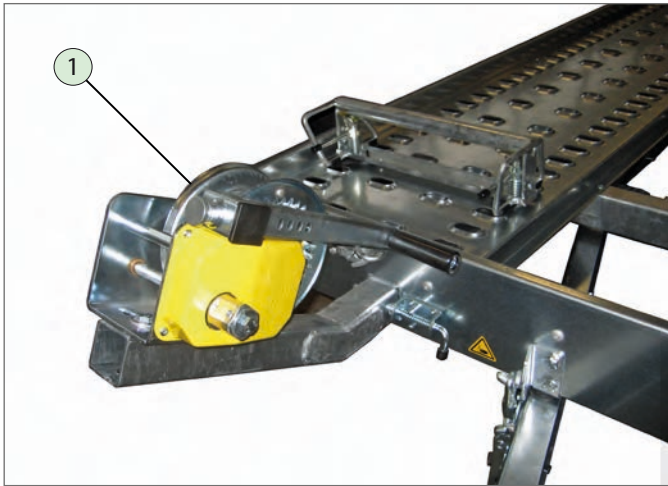

Plug-mounting winch block

1. Winch

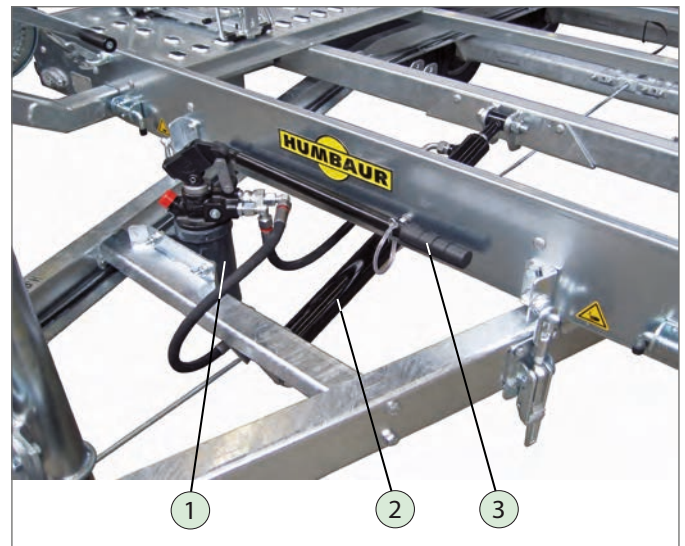

Hydraulic hand pump

1. Hand pump
2. Hydraulic cylinder
3. Pump lever

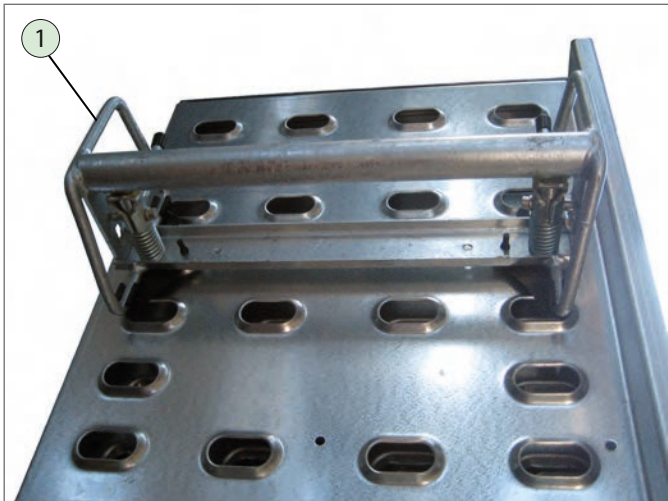

Wheel stop both sides

1. Wheel stop (360 mm)

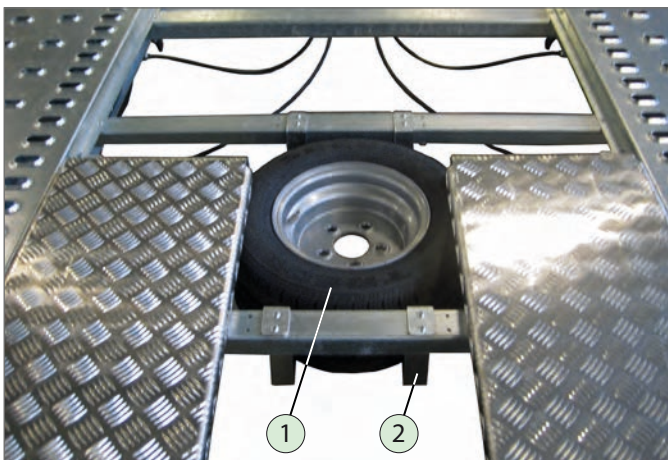

Spare wheel underneath in the chassis

1. Spare wheel
2. Retainer cage

3 Intended Use

- Transporting vehicles
The load platform is operated automatically by weight redistribution. As an option, the load platform can be operated with a manual hydraulic pump.
The vehicle can be pulled up using the winch.

4 Foreseeable Misuse

- Driving with unsecured drive-up ramp.
- Driving with load platform not locked.
- Loading the trailer with incorrectly set track width on the drive-up ramps.
- Driving with unsecured winch block.
- Non-observance of the safety instructions in the operating instruction manual "Trailers up to 3.5 to - General Points (Part 1)".

5 General Safety Instructions

WARNING



Automatic lowering of the load platform!

Crush hazard for hands / fingers when loading at the front edge of the loading platform edge.

- ▶ Keep your hands away from the crush area.
- ▶ Allow the the load platform to lower automatically. Never try to stop it.

- ▶ Wear  and .



Automatic lowering of the load platform!

Crush hazard for feet / persons caused by rear underride guard when lowering the load platform.

- ▶  Keep persons away from the area around the underride guard during lowering.



Moving load platform!

You could fall if you step onto the load platform during the loading and unloading process and during automatic movement.

- ▶ Take particular care when stepping onto the load platform.

- ▶ Wear .

6 Loading and Unloading

6.1 Load distribution

WARNING

Negative/low support load - danger of skidding!

If the vehicle is loaded incorrectly, you can create a negative or inadequate drawbar load. There is a danger of skidding.

- ▶ Load the vehicle with an even load distribution suitable for the goods to be loaded.
- ▶ Observe the minimum and maximum drawbar load forces of the trailer.
- ▶ Do not exceed the maximum permitted drawbar load of the towing vehicle and trailer coupling.



Observe the information on the maximum permissible vertical load on the drawbar.

 VORSICHT		 CAUTION
Überschreitung der zul. Stützlast! Kann zu Unfällen führen-Schleudergefahr. ▶ Min. 4 % der Anhängerlast einhalten, mehr als 25 kg nicht notwendig. ▶ Zul. Stützlast des Zugfahrzeugs beachten!		Exceeding the permissible vertical load! Can lead to accidents-risk of skidding. ▶ Min. 4 % of the trailer load to comply, more than 25 kg are not necessary. ▶ Perm. Note vertical load of the vehicle!

Correct load distribution

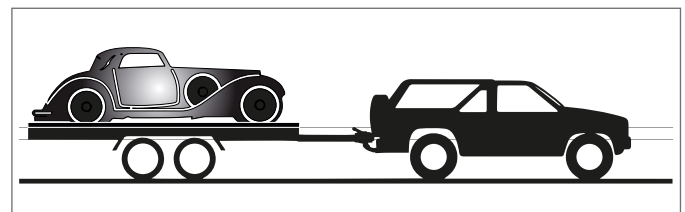

Vehicle loaded correctly

The trailer and the towing vehicle are stable with all wheels on the ground.

Incorrect load distribution

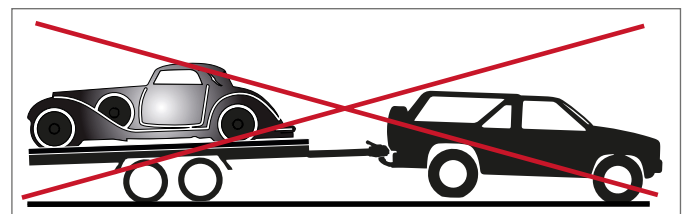

Vehicle loaded incorrectly

The trailer is tilting backwards; the towing vehicle is tilting forwards = the support load is too low or negative.

The rear axle on the tandem trailer and the front axle of the towing vehicle are excessively loaded.

6.2 Securing a load



Vehicle lashed

1. Wheel stop
2. Lashing strap

- ▶ Lash all wheels of the vehicle with appropriate car lashing straps for vehicle transport.
- ▶ In addition, use the optional wheel stops for positive load securing.



Insert wheel stop

Lock it

1. Locking lever

- ▶ Position one wheel stop per side in the front area of the load platform - depending on the vehicle.
- ▶ Make sure the direction is correct - see illustration below.
- ▶ Turn the locking levers on both sides up to the stop - towards the drawbar.

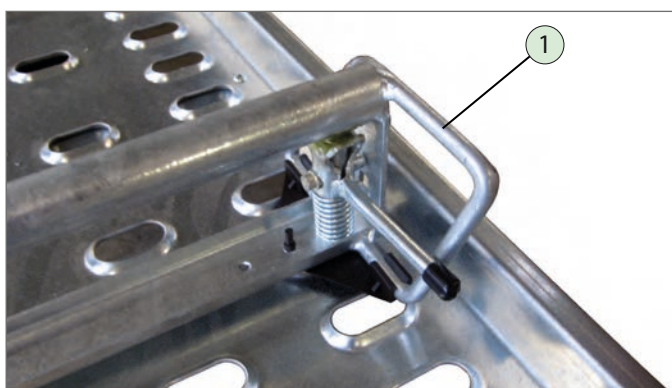

Wheel stop fixed / locked

1. Wheel stop

6.3 Lowering the load platform

WARNING



Automatic lowering of the load platform!

Crush hazard for feet caused by the rear under-ride guard when lowering the load platform.



Keep persons away from the area around the under-ride guard during lowering.

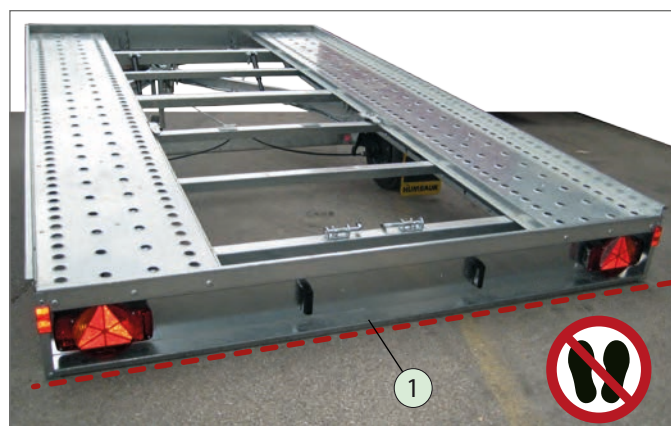

FTK lowered

1. Under-ride guard

Preparing the trailer to be lowered



The trailer should not be able to slip away during the loading process.

- ▶ Place the trailer on solid ground.
- ▶ Secure the trailer so that it cannot roll away or couple it to the towing vehicle first.

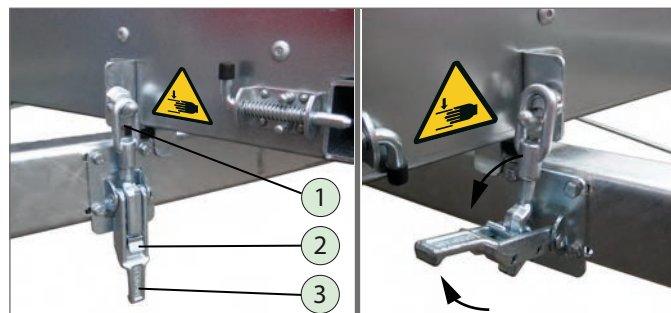

Open the interlocks

1. Eyebolt
2. Securing device
3. Handle

Unlock the interlocks on both sides, one after the other.

- ▶ Depress the safety catch on the handle.
- ▶ Pull out the handle at the same time.
- ▶ Swing the released eyebolt out of the locking hook.

The load platform is now unlocked and lowers automatically.

6.4 Positioning the drive-up ramps

CAUTION



Crush hazard!

Fingers / hands can be injured when removing and positioning the drive-up ramps.

- ▶ Remove and position the drive-up ramps carefully. Hold them at the sides.
- ▶ Keep your fingers away from the crush areas.

▶ Wear  .



Sharp edges!

Fingers / hands can be cut on sharp edges when removing and positioning the drive-up ramps.

▶ Wear  .

Removing the drive-up ramps

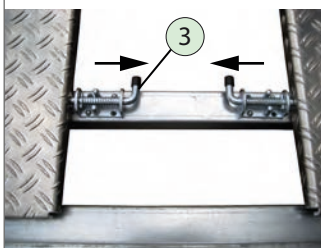
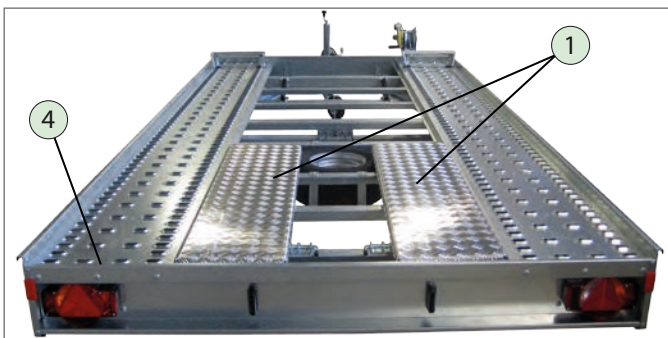

Unlocking the interlocks

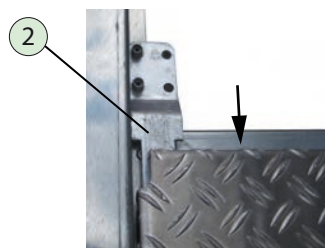

Pulling out the drive-up ramps

1. Drive-up ramps
2. Interlocking plate
3. Drive up ramp lock
4. Chassis edge

Position the drive-up ramps one after the other.

- ▶ Unlock the interlock - fix it in place.
- ▶ Carefully pull out the drive-up ramp.
- ▶ Place the drive-up ramp on the edge of the chassis.

Setting the track width

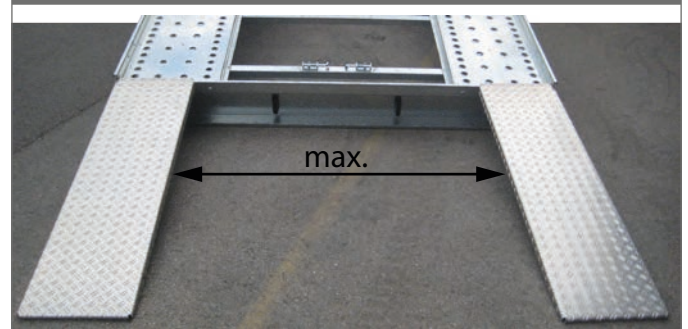
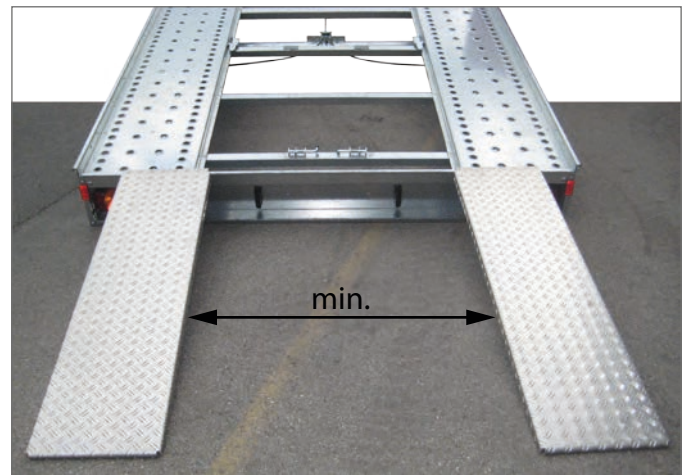

Drive-up ramps positioned at track width

- ▶ Adjust the drive-up ramps to the track width of the vehicle to be loaded.



Make sure that the drive-up ramps are supported / engaged on the chassis edge.

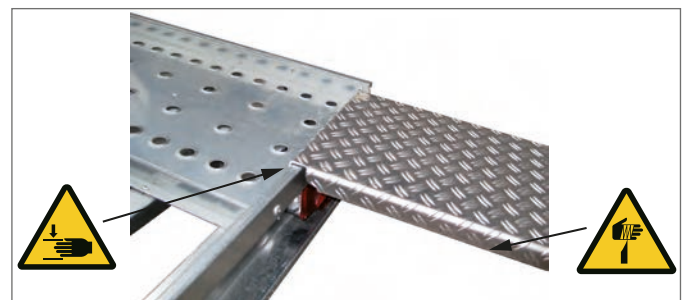

Drive-up ramp engaged

6.5 Loading the Trailer

 Make sure that the trailer is secured so that it cannot roll away.

		
WARNING		WARNING
Unzureichende Beleuchtung beim Be- und Entladen! Erhöhte Unfallgefahr. ► Sichern Sie den Anhänger mit zusätzlichen Signaleinrichtungen.		Inadequate lighting during loading and unloading! Increased risk of accidents. ► Secure the trailer with additional signalling devices.

- Make sure that road traffic safety is not impaired when loading and unloading the trailer.
- If necessary, use additional signalling devices, e.g. signs, barriers.

WARNING



Automatic lowering of the load platform!

Crush hazard for hands / fingers caused by the front edge of the loading platform when loading.

- Keep your hands away from the crush area.
- Allow the the load platform to lower automatically. Never try to stop it.

► Wear  .



Moving load platform!

You could fall if you step onto the load platform during the loading and unloading process and during automatic movement.

- Take particular care when stepping onto the load platform.

► Wear  .

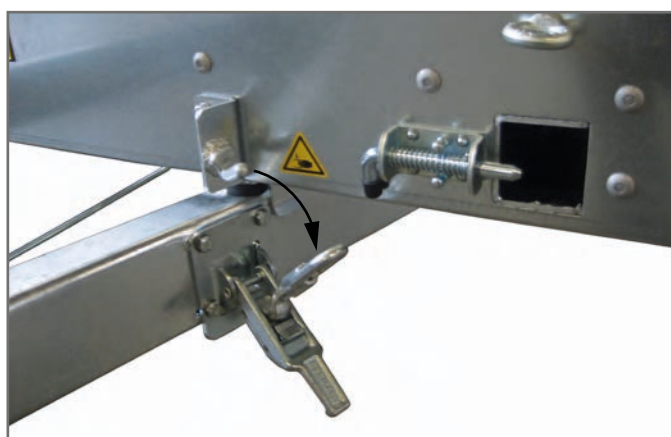

Interlocks opened

- Make sure that the interlocks are open on both sides before loading the trailer.

 The main load of the vehicle to be transported must be located at the front (drawbar) - so that the load platform of the trailer can lower automatically.

Pay attention to the section: 6.1 Load distribution

6.5.1 Loading the vehicle



Loading process (example)

- Drive onto the trailer carefully and not too quickly - the load platform can lower abruptly and can crash into the drawbar.
- Drive up to the wheel stops (if present).
- Use the winch to load a broken down vehicle.
- Make sure that the position of the winch (3 adjusting positions) is set to the vehicle to be loaded - danger of collision.
 - Handling the winch, see Operating instruction manual "Car trailer" (Part 1).



Never exceed the maximum permitted total weight and vertical drawbar load of your trailer.



Observe the maximum permitted vertical drawbar load of your towing vehicle and trailer coupling.

- Lash the vehicle properly. Pay attention to section: 6.2 Load Securing

6.5.2 Securing the load platform

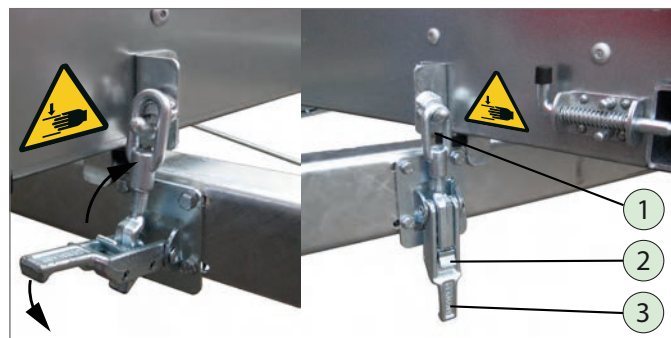

Closing interlock

Locking interlock

1. Eyebolt
2. Securing device
3. Handle

Lock the interlocks on both sides, one after the other.

- Swing the eyebolt onto the locking hook.
- Push the handle downwards.
 - The interlock engages and is interlocked.

6.6 Securing the drive-up ramps

CAUTION



Crush hazard!

Fingers / hands can be crushed when positioning the drive-up ramps.

- ▶ Position the drive-up ramps carefully. Hold them at the sides.
- ▶ Keep your fingers away from the crush areas.
- ▶ Wear  .



Sharp edges!

Fingers / hands can be cut on sharp edges when positioning the drive-up ramps.

- ▶ Wear  .

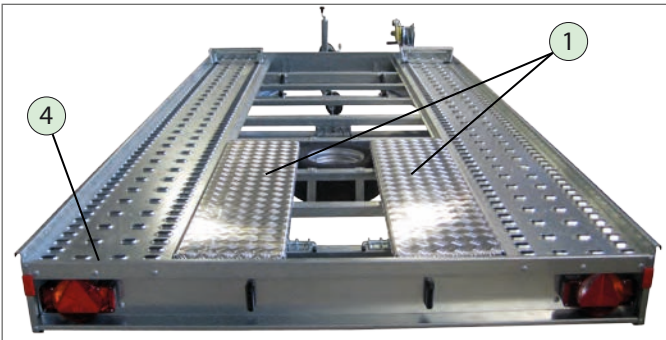

Sliding the drive-up ramps in

Interlocks unlocked

1. Drive-up ramps
2. Drive up ramp lock
3. Interlocking plate
4. Chassis edge

Position the drive-up ramps one after the other.

- ▶ Make sure that the interlocks are unlocked on both sides.
- ▶ Place the drive-up ramp on the edge of the chassis.
- ▶ Slide the drive-up ramp in carefully. They need to be inserted into the locking plate.
- ▶ Use the lock to interlock the drive-up ramp.

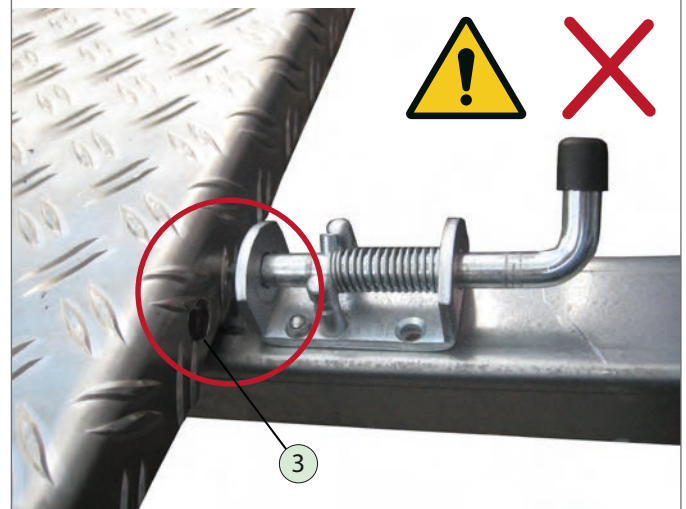
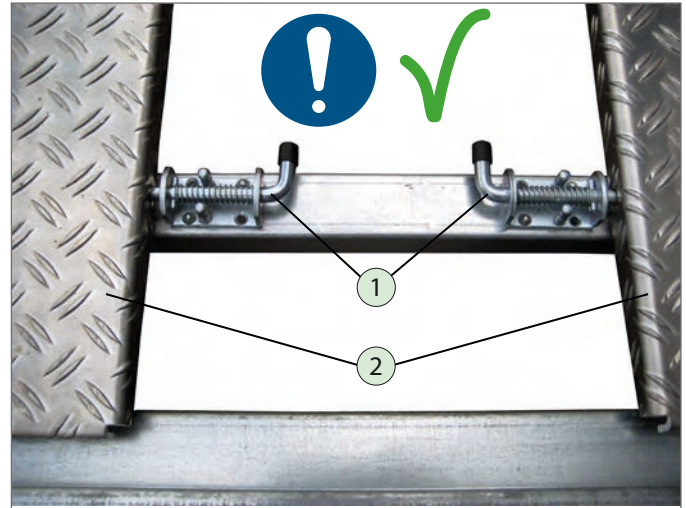

Drive-up ramps locked

1. Drive-up ramp interlocks
2. Drive-up ramps
3. Locking hole

- ▶ Check that the interlocks are engaged in the locking holes in the drive-up ramps on both sides.



The drive-up ramps prevent the spare wheel from falling out.

6.7 Unloading the trailer

WARNING



Automatic lowering of the load platform!

Crush hazard for persons caused by the rear underride guard when lowering the load platform.

- ▶  Keep persons away from the area around the underride guard during lowering.



Moving load platform!

You could fall if you step onto the load platform during the loading and unloading process and during automatic movement.

- ▶ Take particular care when stepping onto the load platform.

- ▶ Wear .

- ▶  Make sure that the trailer is secured so that it cannot roll away.

 WARNUNG Unzureichende Beleuchtung beim Be- und Entladen! Erhöhte Unfallgefahr. ▶ Sichern Sie den Anhänger mit zusätzlichen Signaleinrichtungen.		 WARNUNG Inadequate lighting during loading and unloading! Increased risk of accidents. ▶ Secure the trailer with additional signalling devices.
---	---	---

- ▶ Make sure that road traffic safety is not impaired when loading and unloading the trailer.
- ▶ If necessary, use additional signalling devices, e.g. signs, barriers.

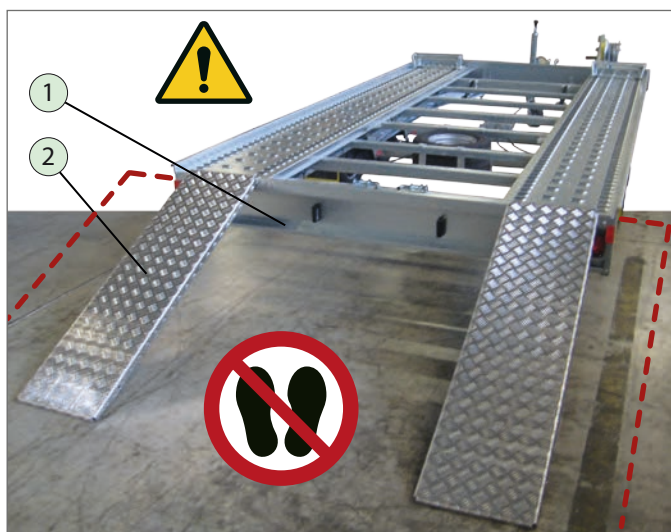

Drive-up ramps positioned for unloading

1. Underride guard
2. Drive up ramp

6.7.1 Unloading the vehicle



Unloading process (example)

1. Drive up ramp
 2. Underride guard
- ▶ Make sure that the vehicle to be unloaded is secured from rolling away. (Handbrake applied)
 - ▶ Remove the drive-up ramps. Adjust them to the correct track width.
 - ▶ Release all the car lashing straps and stow them away.
 - ▶ Open the interlocks on the load platform.
 - ▶ Slowly move / drive the vehicle to be unloaded down. Make sure that the drive-up ramps do not slip away and that the wheels on the vehicle to be unloaded drive centrally up the ramps.
 - ▶ Place the drive-up ramps and lock them with the interlocks.
 - ▶ Push the load platform down at the front edge of the load platform and secure the load platform with the eccentric clamping locks.

7 Driving



Before driving off, make sure that the maximum permitted loads (payload and drawbar load) are not exceeded.



Observe the maximum permitted towing load and drawbar load of your towing vehicle and trailer coupling.

- ▶ If necessary, check the weight information for the goods to be loaded (vehicle).

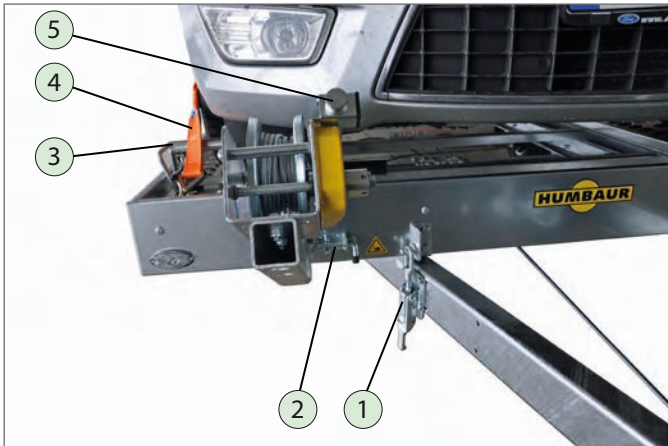

Vehicle secured

1. Interlocks load platform
2. Interlock winch block
3. Wheel stop
4. Lashing strap
5. Winch operating lever

- ▶ Carry out a departure check (see the operating instruction manual "Trailers up to 3.5 to (General Points - Part 1)".
- ▶ Check that:
 - the load platform,
 - winch block,
 - drive-up ramps,
 - wheel stops,
 - winch operating lever,
 - spare wheelare secured.

8 Parking



Observe the general safety and warning instructions on parking your trailer safely in the operating instruction manual "Trailers up to 3.5 to (General Points - Part 1)".

- ▶ In addition, make sure that
 - the load platform is secured with the locks.
 - the drive-up ramps are in place and secured.

9 Cleaning/Maintenance/Service

9.1 Care/Cleaning



Observe the safety instructions and instructions for general cleaning/care of trailers in the general operating instructions manual "Trailers up to 3.5 to (General Points - Part 1)".

Cleaning the gas-struts



The service life, functionality and safety of your trailer depends to a large extent on the regular maintenance/care of the gas-struts.

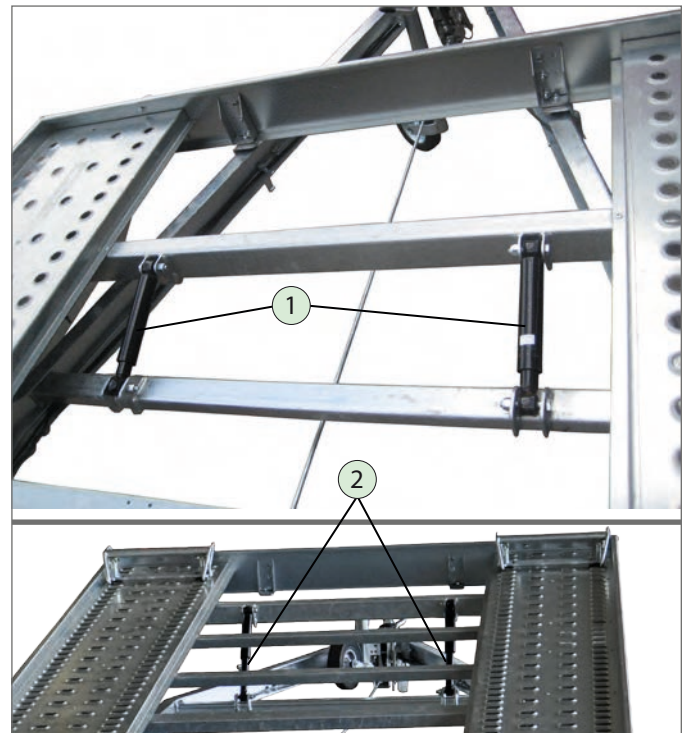

Gas-struts retracted / extended

1. Gas-strut
2. Gas-strut piston

- ▶  During spraying, do not aim the water jet directly at the gas-struts.
- ▶ Check for any contamination of the gas-struts and remove if necessary after each time you use the trailer.
- ▶ Clean the gas-strut piston in the extended condition with a clean dry cloth.
- ▶ Do not scratch or paint the gas-strut or treat it with aggressive media (abrasives).

9.2 Maintenance/Serviceing

9.2.1 Tyres/Wheels

The following tyre sizes can be used on FTK trailers:

Tyre type	p _{max.} in bar
195 / 50 R 10 C	6.25

Table: Tyre size / Tyre pressure

- ▶ Check the tyre pressure on all wheels on a regular basis and before long journeys (see the table "Maintenance work" in the operating instruction manual "Trailers up to 3.5 to (General Points - Part 1)").

9.2.2 Gas-struts



The gas-struts are maintenance-free, to a large extent. The damping effect will decrease after long periods of use and long intervals of use.

The gas-struts and their fixings need to be regularly checked for oil leaks, damage, ageing, breakage, and material fatigue.

Servicing work must only be carried out by qualified experts.

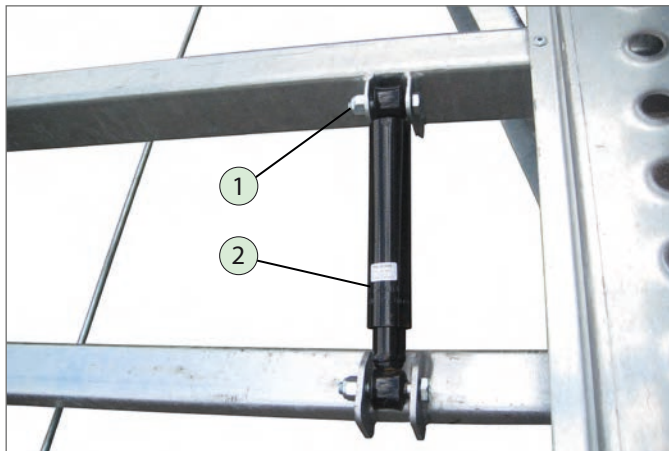

Gas-strut

1. Fixing bolt / nut
2. Gas-strut designation

- ▶ Check the screwed connections for secure seating, and tighten if necessary.
- ▶ Check the dampers visually for oil leaks.
- ▶ If the damping effect reduces or if there are visible oil leaks, replace the gas-struts.
Use only genuine spare parts, see designation / type No. on the gas-strut.

9.2.3 Stops



WARNING



Worn / displaced stops!

Worn / displaced stops can lead to the interlocks on the load platform coming loose - danger of accident.

- ▶ Carry out regular checks and adjustment of the stops.
- ▶ The checking interval depends on the frequency of use of your trailer.
Carry out a check at least every 6 months.

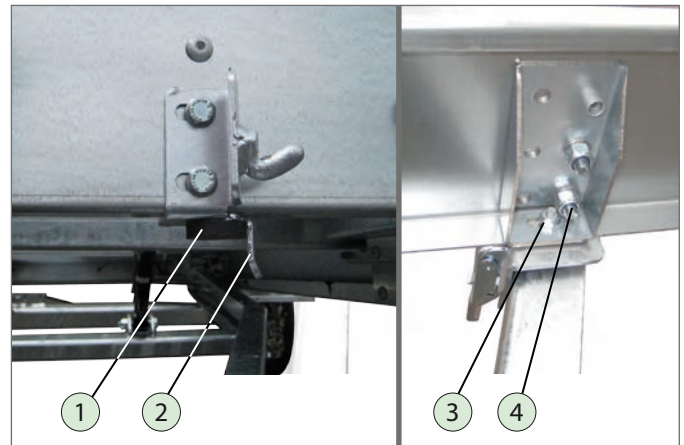

Checking and adjusting the stops

1. Rubber buffer
2. Inlet tongue
3. Fixing bolt / nut rubber buffer
4. Fixing bolt / nut inlet tongue

Rubber buffer

- ▶ Clean the rubber buffers (right and left) using a cloth.
- ▶ Check them for signs of wear, porosity.
- ▶ Replace the rubber buffers (right and left) if they are worn.

Inlet tongues

- ▶ Check that the load platform runs proportionally via the inlet tongues onto the drawbar when folding down.
- ▶ Adjust the inlet tongues according to the setting / level of wear.
- ▶ Apply a little multi-purpose grease to the inner faces of the run-in on the inlet tongues, if necessary.

Stops complete

- ▶ Move the load platform up and down (at least twice).
- ▶ Check that the stops (right and left) operate perfectly and that the load platform runs onto the drawbar smoothly.

9.2.4 Load platform interlocks

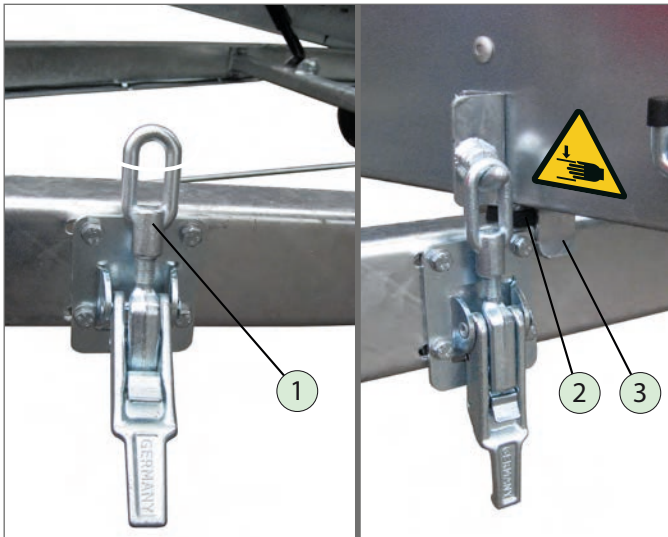

Adjusting the interlocks

1. Eyebolt
2. Rubber buffer
3. Inlet tongue

- ▶ Check the interlocks for signs of wear, fracture, secure closing (creation of tension).

If the build-up of tension by the interlocks reduces:

- ▶ Screw the eyebolt in a little (a couple of threads) and close the interlock.
 - the load platform is drawn in
 - the interlock is under tension.
- ▶ The rubber buffers must be completely in contact with the drawbar.
- ▶ Check that the interlocks pull in with about the same tension on both sides (right and left).

9.2.5 Spare wheel

CAUTION



Crush hazard!

When replacing the spare wheel, your fingers / hands could be crushed between the retainer cage / chassis and the spare wheel.

- ▶ Position the spare wheel above the retainer cage. Lower it carefully into the retainer cage.
- ▶ Keep your fingers away from the crush areas.

- ▶ Wear  .



Falling hazard!

When removing and positioning the spare wheel, you could slip off the load platform / chassis and fall down.

- ▶ When changing the spare wheel (removal) do not climb onto the load platform or chassis.
- ▶ Remove / position the spare wheel whilst standing on the ground (intermediate spaces in chassis).

- ▶ Wear  .

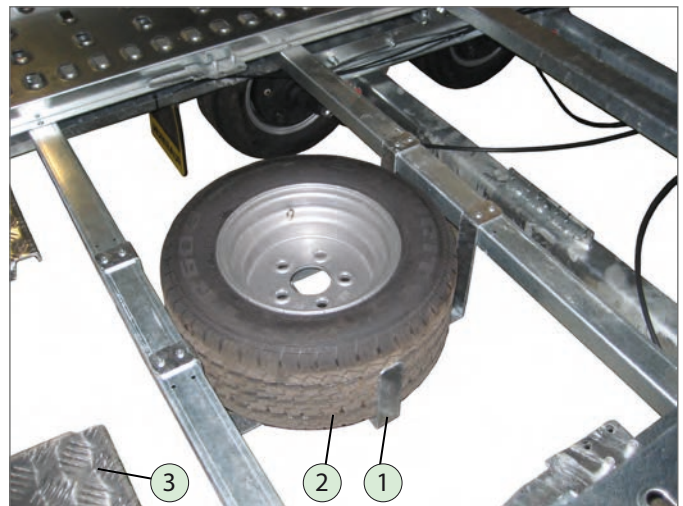

Spare wheel inserted in chassis

1. Retainer cage
2. Spare wheel
3. Drive up ramp



Check the tyre pressure on the spare wheel at regular intervals.

- ▶ Slide the drive-up ramps out slightly (right and left).
- ▶ Remove the spare wheel from the retainer cage.
- ▶ Carry out the wheel change.



- ▶ Place the defective wheel in the retainer cage.
- ▶ Slide in the drive-up ramps and lock them.
 - The spare wheel is secured by the drive-up ramps.



Replace the defective wheel with a genuine replacement wheel.

10 Troubleshooting



If a fault occurs, you can use this table to restore the specific operational functions of the FTK trailer. For further causes of faults and rectification measures, see the operating instruction manual "Trailers up to 3.5 to (General Points - Part 1)".



WARNING



Unsecured trailer! Unexpected start!

Do not go under the chassis when troubleshooting. There is a danger of you being crushed if the trailer starts to move unexpectedly.

- ▶ Make sure that the trailer is secured so that it cannot roll away.
- ▶ Do not actuate the load platform whilst you or anyone else are under the chassis.

Malfunction	Possible cause	Solution
Load platform does not lower automatically.	<ul style="list-style-type: none"> - Gas-struts are contaminated with dirt. - Damping effect has reduced. - Gas-struts are worn out. 	<ul style="list-style-type: none"> - Clean the gas-struts (piston). - Provide manual assistance. - Have the dampers replaced by expert personnel.
Load platform does not rise up automatically.	<ul style="list-style-type: none"> - The load is incorrectly distributed. 	<ul style="list-style-type: none"> - Load (vehicle) to be loaded with its heaviest end towards the drawbar.
Load platform cannot be positioned correctly on the drawbar.	<ul style="list-style-type: none"> - The stops have been moved. 	<ul style="list-style-type: none"> - Check the position of the stops and adjust if necessary.

11 Decommissioning/ Disposing of the Trailer



Observe the safety instructions for decommissioning / disposal of trailers in the general operating instructions manual "Trailers up to 3.5 to (General Points - Part 1)".

11.1 Decommissioning the Trailer

- ▶ Secure your trailer against unauthorised use by third parties, e.g. using wheel clamps.
- ▶ Park your trailer so that it cannot cause any further hazards for third parties, e.g. by tipping over, rolling away, or causing a traffic obstruction.

11.2 Disposal

- ▶ Take the individual parts or the entire trailer to an automotive recycling facility.
The specialists at the automotive recycling facility will dispose of them in the proper manner there.



No liability is accepted for errors or printing errors.
All illustrations are representative.
Deviations and modifications are subject to the model type.
Subject to change without notice.
Copying prohibited.
Printed in Germany.
Version 2019/01